

Thanks for purchasing our computer for LED display system. We attach great importance to the manual. The more you understand the manual, the more easily you can install it. The instructions in this manual will facilitate your operation of this LED control system.

### **About this manual**

This manual contains a general description of BIS-6650LC and the detailed description of its functions, features, installation and dismounting instructions, BIOS settings, etc., which helps you to use this product in a right way.

### **Symbols**



This represents the important information to facilitate your use of this product.



This symbol to make you notice that it may cause damage or data loss, and tell you how to avoid such problems.



This symbol indicates that operation may lead to property loss or bodily injury.

### **Safety Information**

This information can help you to use the product safely. Please strictly follow the labeled warnings and instructions given. We focus on the customer's safety. The products we develop base on safety and availability. However, Power lines and other parts that the motherboard contained may cause a potential risk in the case of improper installing. They may result in bodily injury or property loss. Please follow the manual step by step to avoid these hazards.

### **Validity**

The ceaseless upgrading of computer structure, components and accessories guarantees the superiority and superb quality of the computer, therefore, you may find some features of your NORCO computers is not in accord with the description in this manual. NORCO reserves the right to make changes, without prior notice,

### **Disclaimer**

Except for the accessories attached to the product as specified herein, what is contained in this user manual does not represent the commitments of NORCO Company. NORCO Company reserves the right to revise this User Manual, without prior notice, and will not be held liable for any direct, indirect, intended or unintended losses and/or hidden dangers due to installation or improper operation.

# Content

Chapter 1 Product Introduction.....	1
1.1 Overview .....	1
1.2 Product Specification .....	1
1.3 Product Indicator Diagram.....	2
Chapter 2 Motherboard Description.....	4
2.1 Interface Location and Dimension .....	4
2.2 Installation Steps.....	4
2.3 Install RAM.....	5
2.4 Jumper Settings.....	5
2.4.1 CMOS Clear/Hold Jumper Setting (JCC) .....	5
2.4.2 Hardware Switch for System Auto Boot Upon Power On (JAT) .....	7
2.4.3 COM2 Jumper Setting (J1, J2) .....	7
2.4.4 LVDS Rated Voltage Select Jumper (J8) .....	8
2.5 Interfaces Description.....	9
2.5.1 SATA Interface (SATA1, SATA2, PWROUT) .....	9
2.5.2 Serial Ports (COM) .....	10
2.5.3 Display Interfaces (VGA, DVI, LVDS) .....	11
2.5.4 LVDS Backlight Control Interface (J2) .....	13
2.5.5 USB Ports (USB_LAN1, USB_LAN2, USB56, J6) .....	14
2.5.6 Keyboard & Mouse Connector (KBMS) .....	15
2.5.7 Programmable Input/Output Interface (JGP) .....	16
2.5.8 Power Interface (PWR1, PWR2) .....	16
2.5.9 FAN Connector (CPU_FAN) .....	17
2.5.10 JLPC (JLPC) .....	18
2.5.11 Audio Interface (JACKHDA, J11) .....	19
2.5.12 Front Panel Connector (JFP) .....	20
2.5.13 SO-DIMM Slot (SO-DIMM) .....	22
Chapter 3 Computer Installation and Use.....	23
3.1 Install Computer Peripheral Accessories .....	23
3.1.1 DVI Interface Connection.....	23
3.1.2 COM Device Connection .....	23

3.1.3 PS/2 Keyboard and Mouse Connection .....	23
3.1.4 Power Cable Connection .....	23
3.2 Install Computer Software .....	24
3.2.1 Install Operating System .....	24
3.2.2 Install Drivers .....	24
3.3 BIS-6650LC BIOS SETUP .....	24
AMI BIOS Description .....	25
BIOS Settings .....	25
3.1 Main Menu .....	26
3.2 Advanced Menu .....	26
3.2.1 ACPI Settings .....	27
3.2.2 APM Configuration .....	28
3.2.3 CPU Configuration .....	28
3.2.4 SATA Configuration .....	30
3.2.5 USB Configuration .....	31
3.2.6 Super IO Configuration .....	32
3.2.7 H/W Monitor .....	33
3.2.8 Serial Port Console Redirection .....	33
3.3 Chipset Menu .....	34
3.3.1 South Bridge .....	34
3.4 Boot Menu .....	35
3.5 Security Menu .....	37
3.6 Save & Exit Menu .....	37
<b>Chapter 4 Install and Replace Computer Components .....</b>	<b>39</b>
4.1 Remove Computer Cover .....	40
4.2 Replace DIMM .....	41
4.3 Install CF Card .....	41
4.4 Mounting Bracket .....	42
<b>Appendix .....</b>	<b>43</b>
Appendix 1: Driver Installation .....	43
Appendix 2: Watchdog Programming Guide .....	44
Appendix 3: GPIO Instruction .....	46
Appendix 4: Glossary .....	47

## Packing List

Thanks for purchasing NORCO products. Please check your package carefully according to the checklist below. If you find any components lost or damaged, please contact your retailer.

- |                         |       |
|-------------------------|-------|
| ■ BIS-6650LC            | 1 pcs |
| ■ User Manual           | 1 pcs |
| ■ Drivers and Utilities | 1 pcs |
| ■ DVI Cable             | 1 pcs |
| ■ Power Adaptor         | 1 set |
| ■ Wall Mount Bracket    | 1 set |
| ■ Screws                | 1 bag |

# Chapter 1 Product Introduction

## Chapter 1 Product Introduction

### 1.1 Overview

A compact hardware platform specially designed for LED control system in digital signage applications. It is based on Mini-ITX motherboard, powered by Intel Atom N2800/D2500/D2550 CPU. System offers high performance with industrial-grade reliability. Rich I/O: 4x USB2.0 /2x COM /1x VGA /1x DVI-D /2x LAN, 1x Mini PCIe SSD(optional).

The industrial grade embedded boards, SSD support, VGA and DVI interface and compact fanless design make BIS-6650LC a perfect solution for Kiosk, Digital Signage, LED controlling, Advertising and other embedded applications.

### 1.2 Product Specification

Model		BIS-6650LC
Platform		Intel
Chassis	Color	Black
	Dimension	355mm× 194mm× 50mm(W×D×H)
	Structure	ICEFIN fanless enclosure
	Material	Aluminium alloy
Motherboard	Model	MITX-6936
	Processor	Intel Atom N2800/D2500/D2550 1.86GHz
	Chipset	Intel NM10
	Memory	1xDDR3 SO-DIMM supports 800/1066MHz RAM upto 4GB
Storage	CF	N/A
	SSD	1x Mini PCIe SSD(optional)
	HDD	1x 2.5" HDD Bay
System Features	Network	Realtek RTL8111E, 10/100/1000Mbps, 2x LAN
	USB	4x USB2.0

	Serial Port	1x RS-232(DB9),1x RS-232/485
	Display	1x VGA,1x DVI-D
	Cooling System	Fanless, NORCO ICEFIN cooling design
	Audio	1x Mic-in,1x Line-out,
	Expansions	1x PCI LED card reserve location, 1x Mini PCIe,
	System LED	PWR_LED
	System Control	Power ON/OFF switch
	PS/2	N/A
Power	Power Supply	DC +12V power adapter
Reliability	Mounting	Desktop or Wall Mount
	Operating Temp	0~55 celsius degree
	Storage Temp	-40~80 celsius degree
	Relative Humidity	5%~95% relative humidity, non-condensing
	Operating Vibration	0.5g rms/5~500Hz/random operating
	EMC	CE/FCC Class B

### 1.3 Product Indicator Diagram

**1: BIS-6650LC Front View**

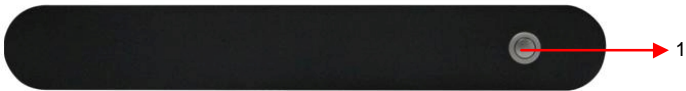

1. Power ON/OFF Button

**2: BIS-6650LC Rear View**

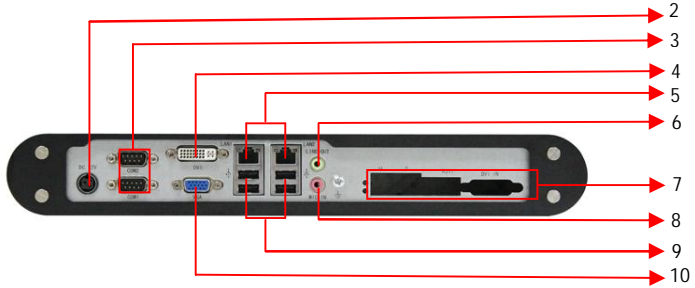

- 2. DC 12V
- 3. 2x COM
- 4. DVI
- 5. 2x Gigabit Ethernet
- 7. LED Controller
- 8. Line-in
- 9. 2x USB 2.0
- 10. VGA
- 6. Line-out



## Chapter 2 Motherboard Description

## Chapter 2 Motherboard Description

### 2.1 Interface Location and Dimension

The following picture shows the front panel interfaces location and the dimension of the board MITX-6936. Please pay attention to the installation procedures. Improper installation of any components will lead to system malfunction.

**Note: Before installation, please put on the anti-static gloves, in case that the static electricity causes damage to the motherboard.**

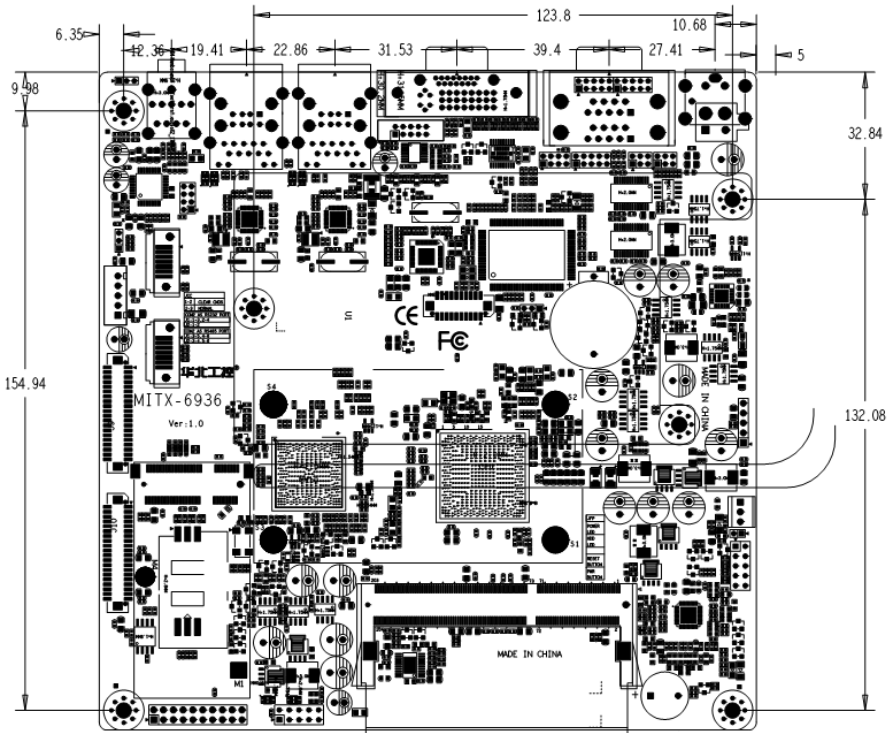

MITX-6936 Dimension Diagram

### 2.2 Installation Steps

Please follow the steps below to assemble your computer:

1. Refer to the manual and adjust all the jumpers of MITX-6936
2. Install RAM

3. Install other expansion cards
4. Connect all signal cable, power cable, panel control cable and power supply unit.
5. Start the computer and complete the BIOS settings.



**Key components of this motherboard are integrated circuit, and these components will be easily damaged by electrostatic influence. So, before installing the motherboard, you should always keep the following precautions in mind:**

1. Hold the board by edges, don't touch any components or plug and socket pins
2. Wear anti-static gloves/wrist strap while touching the integrated circuit components, such as CPU, RAM, etc.
3. Put those unused or uninstalled components in static shielding bags or trays
4. Please first check the power switch is off before connecting the power plug

## 2.3 Install RAM

Board with one DDRIII slot, please pay attention to following remarks before installing the RAM module:

1. First, please align the notch of the memory bank with the notch on the socket and press the memory bank slowly into the socket.
2. Please choose the proper memory bank that matches your motherboard

## 2.4 Jumper Settings

Please refer to following instructions to do jumper settings before installing your hardware devices.

**Remark:** How to identify the PIN1 of all jumpers and interfaces: Please observe the word mark on the side of the plug socket, which will be a "1" or bold line or triangular symbol; And please look at the back of PCB, each with a square shape will be the PIN 1; and all the jumpers' PIN1 have a white arrow on the side.

### 2.4.1 CMOS Clear/Hold Jumper Setting (JCC)

CMOS is powered by the onboard button cell. Clear CMOS will lead to permanent elimination of previous system settings and back to the original system setting (factory default).

Steps: (1) Turn off the computer and disconnect the power supply

- (2) Use Jumper Cap JCC Pin1-2 short for 5~6 sec. Then restore the default setting

with Pin2-3 connected

- (3) Turn on the computer, then press “DEL” key to enter BIOS setting and reload optimal defaults.
- (4) Save and Exit

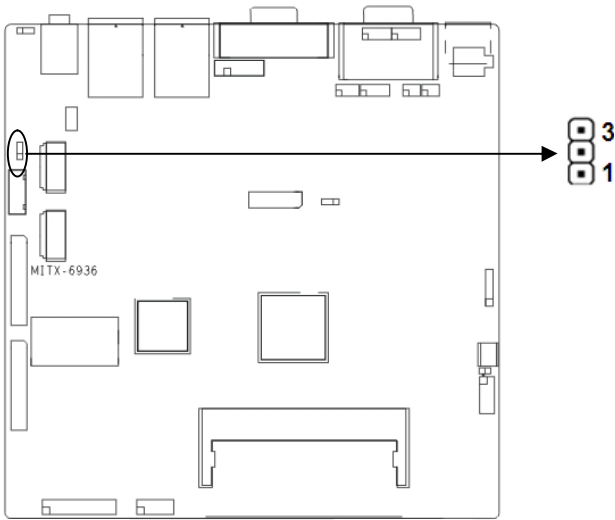

JCC:

Setting	JCC
1-2	BIOS back to initialization (factory default)
2-3	Normal Status, System default

**⚠ Do not clear CMOS when the computer is power on, otherwise, it will cause damage to the motherboard!**

### 2.4.2 Hardware Switch for SystemAuto Boot Upon Power On (JAT)

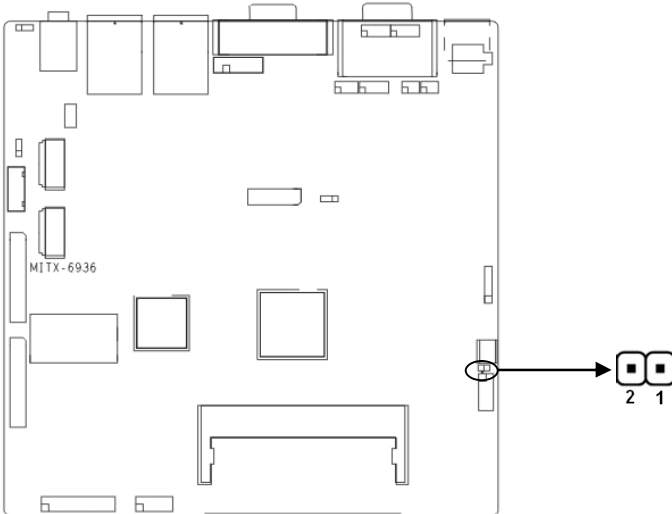

JAT:

Setting	JAT
Open	Disable this auto boot function
Close	Enable this auto boot function

### 2.4.3 COM2 Jumper Setting (J1, J2)

J1, J2 jumpers are used to configure COM2 transmission mode. COM2 supports RS232/RS485. Default mode as RS232.

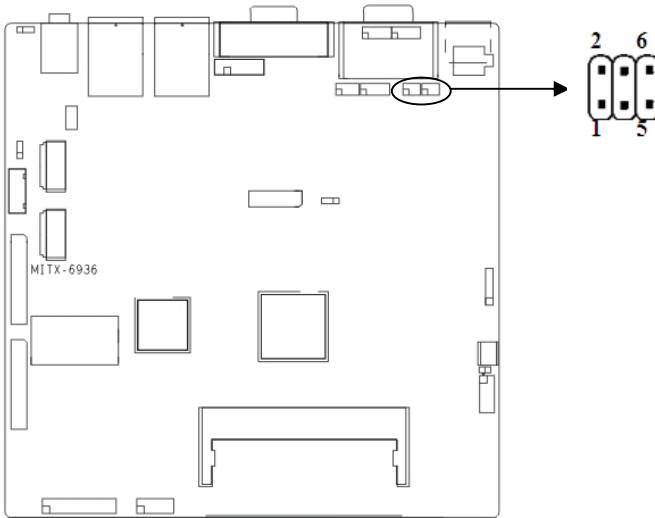

COM2 RS232 (default)		COM2 RS485		
J1	1-3 2-4	J1	3-5	4-6
J2	1-2	J2	3-4	5-6

#### 2.4.4 LVDS Rated Voltage Select Jumper (J8)

Before using the LVDS, please first check the rated operating voltage.

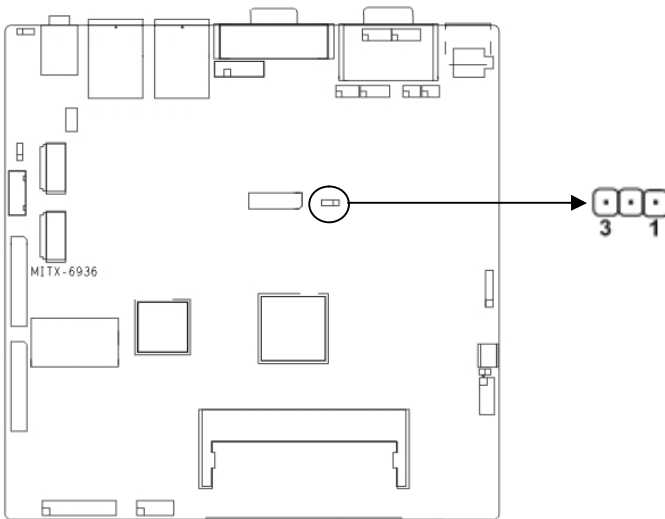

J8:

Setting	3.3V	5V
J8	1-2	2-3

## 2.5 Interface Description

**⚠ Please read the following instructions carefully before you connecting the external connectors in case of any damage caused to the motherboard.**

### 2.5.1 SATA Interface (SATA1, SATA2, PWROUT)

Board provides 2x standard 7 Pin SATA interfaces and one 5Pin PWROUT interface. HDD is power-up through the PWROUT interface with an adapter cable

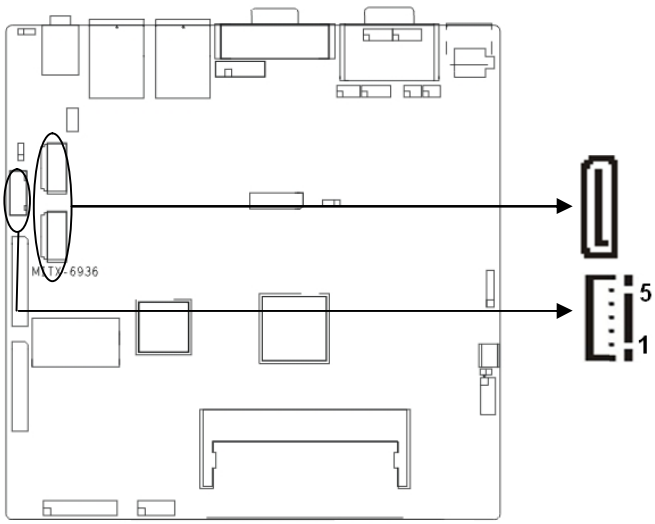

**SATA:**

Pin	Signal Name
1	GND
2	TX+
3	TX-
4	GND
5	RX-
6	RX+
7	GND

**PWROUT:**

Pin	Signal Name
1	+12V
2	GND
3	VCC
4	GND
5	VCC3

**2.5.2 Serial Ports (COM)**

Board provides 2x standard DB9 serial ports( Reserved two Pins :JCOM1, JCOM2)。



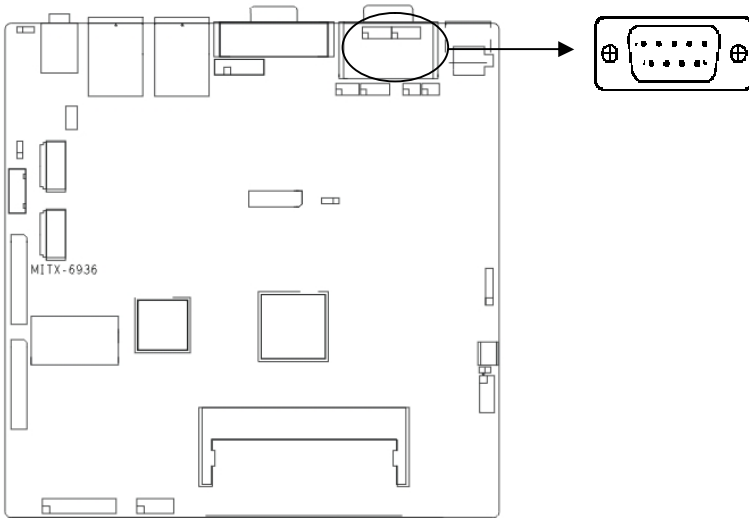

**COM1/COM2:**

Pin	Signal Name
1	DCD
2	RXD
3	TXD
4	DTR
5	GND
6	DSR
7	RTS
8	CTS
9	RI

**2.5.3 Display Interface (VGA, DVI, LVDS)**

1x standard DB15 VGA port , 1x DVI-D, 1x standard single channel 18/24bit LVDS port.

Reserved one 2×5 Pin VGA Pin optional

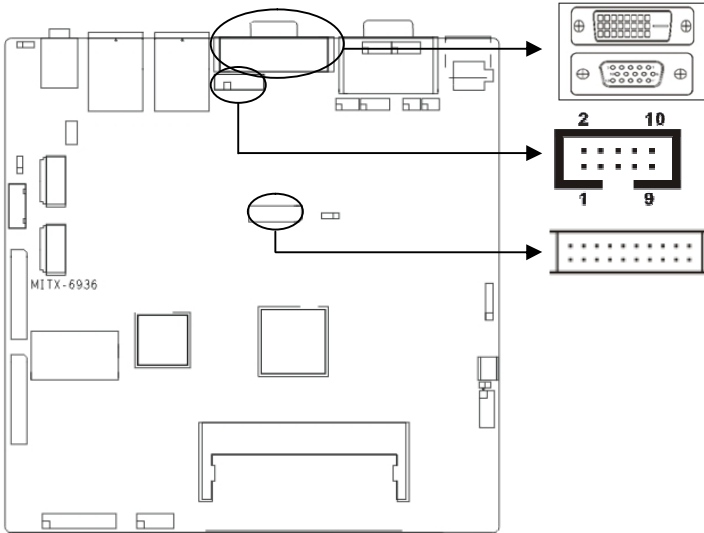

VGA:

Pin	Signal Name	Pin	Signal Name	Pin	Signal Name
1	RED	6	GND	11	NC
2	GREEN	7	GND	12	SDA
3	BLUE	8	GND	13	HSYNC
4	NC	9	+5V	14	VSYNC
5	GND	10	GND	15	SCL

DVI:

Signal Name	Pin		Signal Name
TDC2#	1	2	TDC2
GND	3	4	NC
NC	5	6	SC-DDC
SD-DDC	7	8	NC
TDC1#	9	10	TDC1
GND	11	12	NC
NC	13	14	VCC
GND	15	16	HP-DETECT
TDC0#	17	18	TDC0
GND	19	20	NC
NC	21	22	GND

TLC	23	24	TLC#
GND	25	26	GND
NC	27	28	NC

LVDS:

Signal Name	Pin		Signal Name
VCC	1	2	VCC
GND	3	4	GND
LA_DATA_N0	5	6	L_DDC_DATA
LA_DATA_P0	7	8	L_DDC_CLK
GND	9	10	GND
LA_DATA_N1	11	12	LA_CLK_N
LA_DATA_P1	13	14	LA_CLK_P
GND	15	16	GND
LA_DATA_N2	17	18	LA_DATA_N3
LA_DATA_P2	19	20	LA_DATA_P3

2.5.4 LVDS Backlight Control (J2)

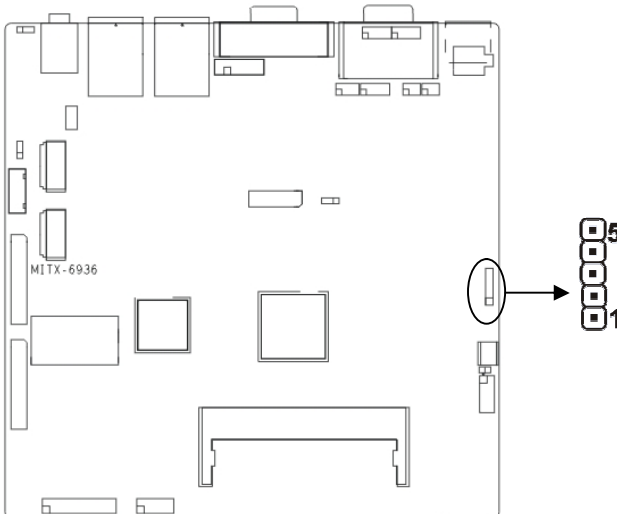

J2:

Pin	Signal Name
1	+12V
2	BKLT_EN

3	GND
4	BKLT_CTRL
5	+5V

**2.5.5 USB Ports (USB\_LAN1, USB\_LAN2, USB56, J6)**

External USB and LAN ports. 2x separate slots provide 2x standard USB2.0 ports and 1x RJ 45 port. USB\_56 is the internal USB port. The one 2x 5Pin header can be converted into 2x standard USB ports. Both sides of the RJ45 network interface with a LED lamp. The yellow one indicates the data transmission status. The green one indicates the network link status. J6 is the LAN LED for LAN 1 and LAN2.

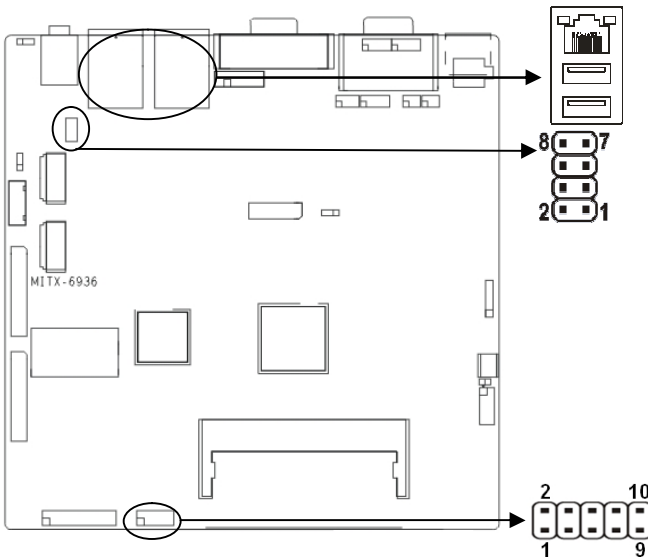

Standard USB Ports:

Pin	Signal Name
1	+5V
2	USB DATA-
3	USB DATA+
4	GND

USB\_56:

Signal Name	Pin		Signal Name
VCC	1	2	GND
USB DATA-	3	4	GND

USB DATA+	5	6	USB DATA+
GND	7	8	USB DATA-
GND	9	10	VCC

LED STATUS:

LILED (Green/Orange)	Function	ACTLED (YELLOW)	Function
Green	1000M LINK	FLASH	Data Transferring
Orange	100M LINK	FLASH	Data Transferring
OFF	10M	FLASH	Data Transferring
OFF	NO LINK	OFF	No Data

### 2.5.6 Keyboard & Mouse Connector (KBMS)

One 2×4Pin header, to be converted to PS keyboard and mouse connector with an adapter cable.

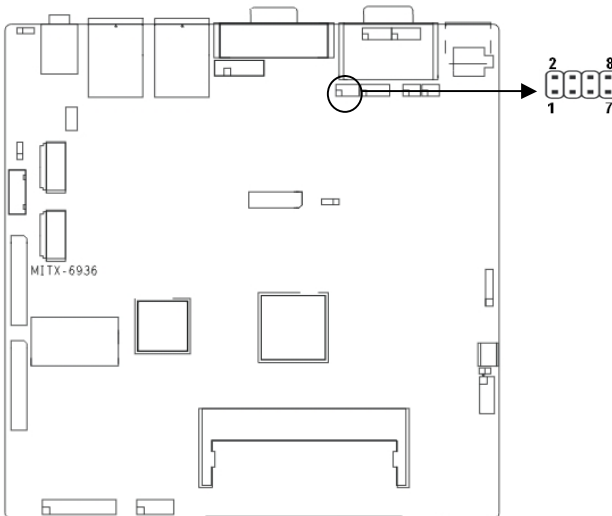

KBMS:

Signal Name	Pin		Signal Name
VCC5	1	2	MS_CLK
GND	3	4	MS_DATA
KB_DATA	5	6	GND
KB_CLK	7	8	VCC5

**2.5.7 Programmable Input/Output (JGP)**

General purpose programmable Input/Output. 8bit GPIO, one 2x 5Pin header.

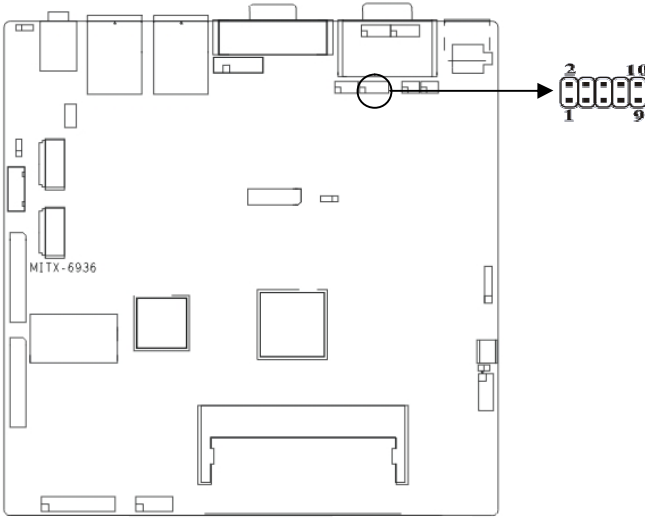

GPIO:

Signal Name	Pin		Signal Name
SIO_GP30	1	2	VCC
SIO_GP31	3	4	SIO_GP34
SIO_GP32	5	6	SIO_GP35
SIO_GP33	7	8	SIO_GP36
GND	9	10	SIO_GP37

**2.5.8 Power Interface (PWR1, PWR2)**

Inbuilt power interface PWR1 is reserved. PWR2 is the default external power interface.

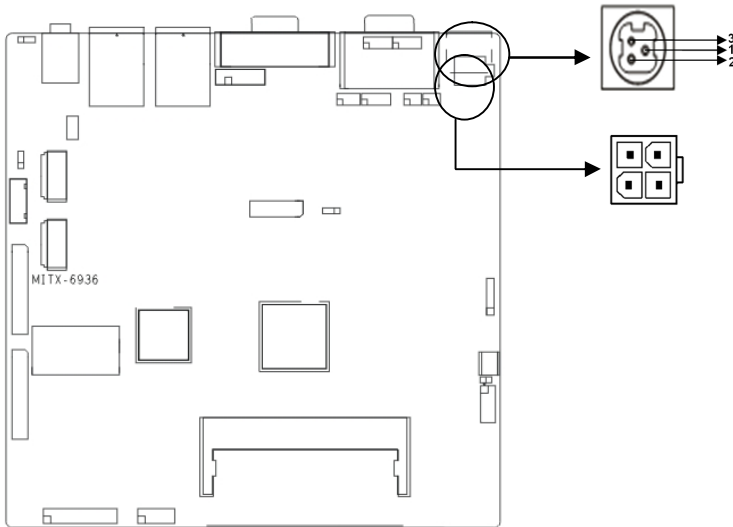

**Inbuilt Power Interface PWR1:**

Pin	Signal Name
1	GND
2	GND
3	+12V
4	+12V

**External Power Interface PWR2:**

Pin	Signal Name
1	+12V
2	GND
3	NC

**2.5.9 FAN Connector (CPU\_FAN)**

Board provides 1x CPU\_FAN interface. Please pay attention to following remarks:

(1) The electric current of the FAN  $\leq 350\text{mA}$  (4.2W, 12V)

(2) Please check if the fan cable matches the socket wiring. The power cable is generally the red one in the middle. Then the grounding cable (black) and the FAN speed pulse signal out cable (other color). Some FANs without speed detect function but the output voltage up to 12V, which will damage the motherboard. Recommend to use FANs with speed detect function.

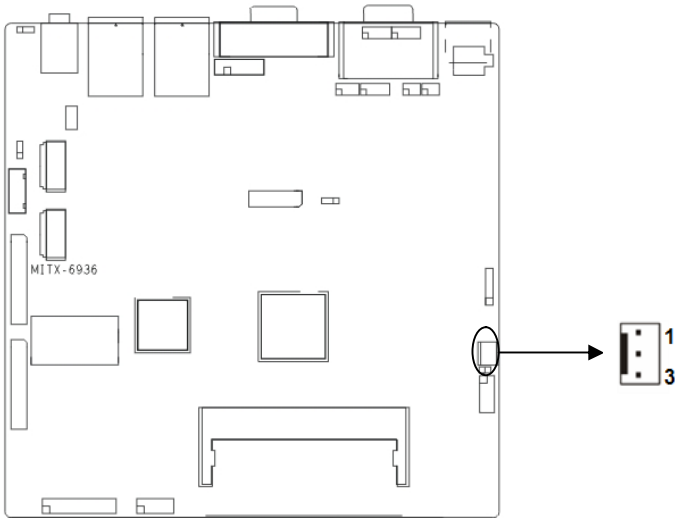

CPU\_FAN:

Pin	Signal Name
1	GND
2	+12V
3	Speed detect

### 2.5.10 JLPC (JLPC)

Board provides one 2×10Pin JLPC (Low Pin Count Interface Specification) to connect external devices.



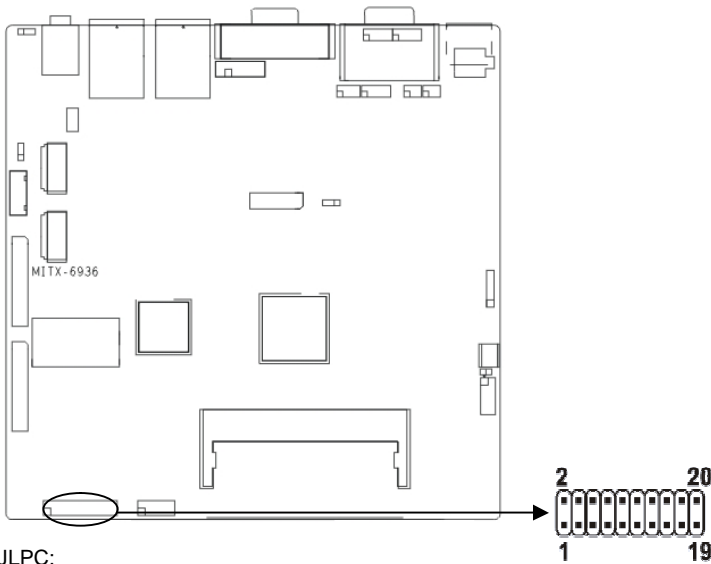

JLPC:

Signal Name	Pin		Signal Name
CLK_LPC	1	2	GND
LFRAME_N	3	4	CLK_LPC_48M
LPC_RST#	5	6	VCC
LPC_AD3	7	8	LPC_AD2
VCC3	9	10	LPC_AD1
LPC_AD0	11	12	GND
SMB_CLK	13	14	SMB_DATA
3.3VSB	15	16	SIO_SERIRQ
GND	17	18	NC
PM_SUS_STAT#	19	20	LDRQ_1

### 2.5.11 Audio Interface (JACKHDA, J11)

Board provides one Audio interface. Green is the Line-out , Red is the Mic-in. Internal Audio extension pin ,1x Line in Pin.

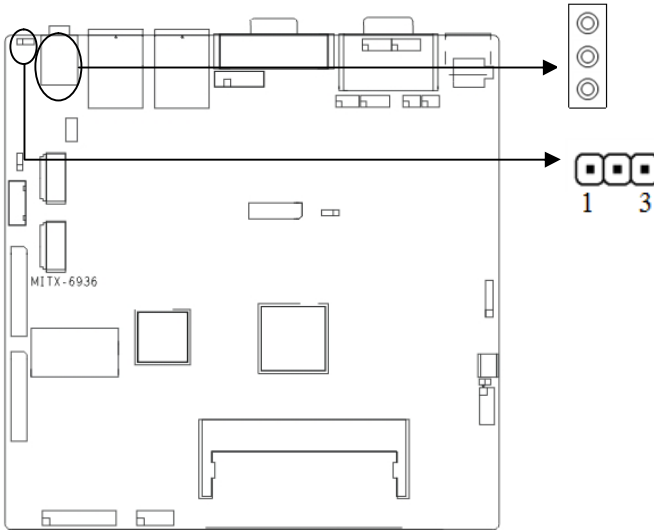

J11:

Pin	Signal Name
1	AGND
2	LINE_IN_L
3	LINE_IN_R

### 2.5.12 Front Panel Connector (JFP)

One 2x 5Pin front panel pin, is used to connect all the function buttons and LED Lamp on the front panel.

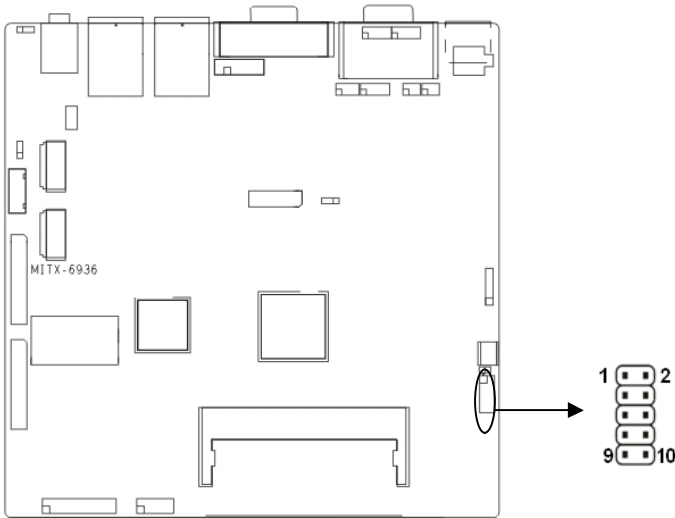

JFP:

Signal Name	Pin		Signal Name
POWER LED+	1	2	POWER LED-
HD LED+	3	4	HD LED-
VCC	5	6	BUZZDATA-
RESET BUTTON	7	8	GND
POWER BUTTON	9	10	GND

Please refer to following guide to connect and pay attention to its anode and cathode. Improper connection will lead to system malfunction.

POWER LED
HDD LED
BUZZ
RESET BUTTON
PWR BUTTON

### 1) System Power LED Pins ( pin1, pin2 for PWLED)

Connecting system power LED cable to these pins, (pin 1 is LED anode),when system power switch on, power LED on; When system power switches off, power LED off

**2) HDD LED Pins (J4 pin3, pin4 for HDD LED)**

As a rule, there is a HD LED on the panel of chassis, while HD device (like hard Disk) is reading or writing (no matter which HD device), LED will flash, shows that IDE device is running. Connect IDE LED on chassis panel and these pins (pin3 is LED anode)

**3) Buzzer Pins ( Pin5/Pin6 for SPEAKER )**

To connect external speaker pins

**4) Reset Button Pins(pin7, pin8 for RESET )**

Connect this pins and RESET switch on panel of chassis with cable. When system can not work on, reset can make system restart, without turning on/off the power, thereby it can prolong system life span

**5) Power On/Off Control Pins (pin9, pin10 for POWER BUTTON)**

Connect these two pins with bounce switch on panel of chassis, to switch-on or switch-off the power.

**2.5.13 SO-DIMM Slot (SO-DIMM)**

Board with one single channel SO-DIMM slot supports DDRIII 800/1066 RAM upto 4GB.

## **Chapter 3 Computer Installation and Use**

## Chapter 3 Computer Installation and Use

### Before the installation of computer peripheral accessories

Please follow the safety principles below., which will help to prevent the computer from potential damage and ensure personal safety.

 **Please make sure your computer is not connected with any power supply**

 Only licensed service technicians can carry out maintenance on your computer. The warranty is not within the scope if you open and repair it without the company's authorization

 Disconnect the computer power connector carefully, the power connector has foolproof design, Please must take care and protect the connector pins.

 Before you touch any components of the computer, please make sure your hand touch an unpainted metal surface, it will remove static electricity during the assembly process. During operation, please keep touching the unpainted metal surface, it will be useful for static electricity discharge.

### 3.1 Install Computer Peripheral Accessories

#### 3.1.1 DVI Interface Connection

Both the motherboard and the LED controller board have one DVI port. Motherboard will send video signal to LED controller card. DVI interface of LED controller card is used to receive video signal, then it will send the RJ45 video signal to the large LED screen.



#### 3.1.2 COM Device Connection

Connect the COM devices to the computer serial ports.

#### 3.1.3 PS/2 Keyboard and Mouse Connection

1. Connect the 6PIN PS/2 connector to the computer PS/2 interface
2. Connect the PS/2 mouse interface to the PS/2 mouse connector
3. Connect the PS/2 keyboard interface to the PS/2 keyboard connector

#### 3.1.4 Power Cable Connection

1. Connect the plug of the power adapter to the power interface of computer

2. Connect another plug of the adaptor to the 3-slot plug base

## 3.2 Install Computer Software

 Remark: Please connect the external CD-ROM before your installation.

### 3.2.1 Install Operating System

Please install the operating system according to your applications.

 BIS-6650LC LED control system supports Windows98/2000/XP/NT, Linux/ Unix, etc. NORCO will not provide these OS. Customers need to purchase and install it by themselves. If you have any questions during the installation process, please ask your software supplier. In addition, you can also contact us, we will provide necessary technical support.

### 3.2.2 Install Drivers

 Remark: Please do not press the disk tray when you open or close the DVD tray. Please close the DVD tray if you don't use it. Please do not move the computer when you display your DVD.

Please follow the steps below to install drivers:

- 1: Press the Pop-up button of front drive.
- 2: Please place the Drivers and Utilities disk into the CD-ROM tray.
- 3: Slightly push back tray.
- 4: Please click the relevant menu item from the auto-run menu
- 5: Double-click the driver, and then you can install it according to the screen prompts
- 6: After finishing the installation of some drivers, the system will prompt you to restart your system; when you restart the system, you can install another driver until all programs be installed.
- 7: The installation of all drivers is complete; users can go to Device Manager to check it.

## 3.3 BIS-6650LC BIOS SETUP

It is true that hardware and software are upgrading all the time. When your IPC can not support the newest processor (for example), you should upgrade the BIOS to try to keep up with the latest technology. Upgrading (or flashing) the BIOS is not an easy attempt. To make sure upgrade succeed, please follow the instruction below:

AFUDOS.EXE is the program for BIOS to modify and upgrade, need to be run in DOS mode.

Use boot disk load DOS, run AFUDOS.EXE and write the newest file: XXXX.ROM into the Flash IC.

### **Order Format:**

A:\Afudos XXXX.rom / P /B /N /X /R

If you need to add other parameters, please add <space>/? after the order format.

Remarks:

1. Upgrading BISO may cause your system crash, so please operate carefully.
2. Please use the upgrading program in the CD-ROM provided by us or download the latest program on related websites
3. Please do not power off or reboot the system when upgrading, otherwise, the BIOS maybe be damaged.
4. After BIOS flash, to load default optimum manually
5. Please backup your BIOS before upgrading

## **AMI BIOS Description**

When the computer is power on, BIOS will conduct self-diagnosis to its hardware on motherboard and configure hardware parameter, finally the operating system will take control. BIOS is the communication bridge between hardware and O/S. Correct configuration of BIOS is critical for maintaining system stability and its optimized performance.

## **BIOS Settings**

1. Power on or reboot the computer, self-detection information will show:
2. When message shows as "Press <DEL> to enter setup", pls press <DEL>, then enter into BIOS SETUP Program.
3. Use the “ ← ↑ → ↓ ” to choose the option which your want to modify, press <Enter> to go to its sub-menu.
4. Use the “ ← ↑ → ↓ ”and <Enter> to modify the value of the chosen option, then press ”Enter” to modify BIOS options that you choose
5. At any time, press<Esc> can go back to the father-menu.

**Remark!** BIOS settings have direct impatcs to computer performance. Incorrect configurations will cause damage to the computer and even lead to system halted. Please use BIOS default settings to recovery system. As our company is always ceaselessly update the BIOS SETUP



Utility, so, following BIOS SETUP screens are only for your reference. Some may be different from the BIOS you are using now.

### 3.1 Main Menu

BIOS SETUP UTILITY	
BIOS Information	Set the Date. Use Tab to switch between Date elements.
BIOS Vendor American Megatrends	→← : Select Screen ↑ ↓ : Select Item Enter: Select +/-: Change Opt. F1: General Help F9: Optimized Defaults F10: Save&Exit ESC: Exit
Project Version 6936T101	
Build Date and Time 08/10/2012 08:51:28	
CPU Information	
Intel(R) Atom(TM) CPU D2550 @ 1.86GHz	
Memory Information	
Memory Frequency 1067 MHz (DDR3)	
Total Memory 2048 MB	
System Date [Mon 08/10/2012]	
System Time [08:50:24]	
Version 2.10.1208. Copyright (C) 2010 American Megatrends, Inc.	

System Time

System time format: Hour/Minute/Second

System Date

System Date Format: Week/Month/Day/Year

### 3.2 Advanced Menu

BIOS SETUP UTILITY	
BIOS Information	Enabled or Disabled Boot Option for Legacy Network Devices.
Legacy OpROM Support	
Launch LAN1 PXE OpROM [Disabled]	

<p>Launch LAN2 PXE OpROM [Disabled]</p> <ul style="list-style-type: none"> <li>▶ ACPI Settings</li> <li>▶ APM Configuration</li> <li>▶ CPU Configuration</li> <li>▶ SATA Configuration</li> <li>▶ USB Configuration</li> <li>▶ Super IO Configuration</li> <li>▶ H/W Monitor</li> <li>▶ Serial Port Console Redirection</li> </ul>	<p>→←: Select Screen                  ↑↓: Select Item                  Enter: Select                  +/-: Change Opt.                  F1: General Help                  F9: Optimized Defaults                  F10: Save&amp;Exit                  ESC: Exit</p>
Version 2.10.1208. Copyright (C) 2010 American Megatrends, Inc.	

**Launch LAN1/2 PXE OpROM**

Enables or disables the boot option for legacy network devices connected to LAN1 and LAN2

**3.2.1 ACPI Settings**

BIOS SETUP UTILITY	
<p>ACPI Settings</p>	<p>Select the highest ACPI sleep state the system will enter when the SUSPEND button is pressed.</p>
<p>ACPI Sleep State [S1 (CPU Stop Clock) ]</p>	<p>→←: Select Screen                  ↑↓: Select Item                  Enter: Select                  +/-: Change Opt.                  F1: General Help                  F9: Optimized Defaults                  F10: Save&amp;Exit                  ESC: Exit</p>
Version 2.10.1208. Copyright (C) 2010 American Megatrends, Inc.	

**ACPI Sleep State**

Select the highest ACPI sleep state the system will enter when the suspend button is pressed.

Different modes are defined with different power consumption.

S1 (CPU Stop Clock): CPU stops working while other devices are still connected to power supply.

### 3.2.2 APM Configuration

BIOS SETUP UTILITY		
RTC Power On Function	[Enabled]	Enable or disable System wake on alarm event. When enabled.
RTC Power On Hour	0	System will wake on the
RTC Power On Minute	0	hr::min::sec specified
RTC Power On Second	0	
		→←: Select Screen ↑ ↓: Select Item Enter: Select +/-: Change Opt. F1: General Help F9: Optimized Defaults F10: Save&Exit ESC: Exit
Version 2.10.1208. Copyright (C) 2010 American Megatrends, Inc.		

#### RTC Power On Function

When Enabled, users can set the date and time at which the RTC (real time clock) alarm awakens the system from Suspend mode. The choices :< Enabled>, <Disabled (default)>.

### 3.2.3 CPU Configuration

BIOS SETUP UTILITY	
CPU Configuration	Enabled for Windows XP and

Processor Type	Intel(R) Atom(TM) CPU	Linux (OS optimized for Hyper-Threading Technology) and Disabled for other OS (OS not optimized for Hyper-Threading Technology) .
EMT64	Supported	
Processor Speed	1865 MHz	→ ← : Select Screen ↑ ↓ : Select Item Enter: Select +/-: Change Opt. F1: General Help F9: Optimized Defaults F10: Save&Exit ESC: Exit
Ratio Status	14	
Actual Ratio	14	
System Bus Speed	533 MHz	
Processor Stepping	30661	
Microcode Revision	268	
L1 Cache RAM	2×56 K	
L2 Cache RAM	2×512 K	
Processor Core	Dual	
Hyper-Threading	Supported	
Hyper-Threading	[Enabled]	
Execute Disabled Bit	[Enabled]	
Limit CPUID Maximum	[Disabled]	
EIST	[Disabled]	
CPU C state Report	[Disabled]	
Version 2.10.1208. Copyright (C) 2010 American Megatrends, Inc.		

The read only option contains detailed information of CPU, including CPU manufacturer, model,frequency, L1 Cache, L2 Cache, etc.

**Hyper-Threading**

Disable or enable the Hyper-Threading Technology.

Intel® Hyper-Threading Technology uses resources efficiently, enabling multiple threads to run on each core, and increasing processor throughput.

**Execute Disabled Bit**

When this field is set to Disabled, it will force the XD feature flag to always return to 0. XD can prevent certain classes of malicious buffer overflow attacks when combined with a supporting OS (Windows Server 2003 SP1, Windows XP SP2, SuSE Linux 9.2, RedHat Enterprise 3 Update 3).

Limit CPUID Maximum

The CPUID instruction of some newer CPUs will return a value greater than 3. The default is Disabled because this problem does not exist in the Windows series operating systems. If you are using an operating system other than Windows, this problem may occur. To avoid this problem, enable this field to limit the return value to 3 or lesser than 3.

EIST

To enable or disable the Enhanced Intel SpeedStep Technology (EIST). Enhanced Intel SpeedStep Technology allows the system to dynamically adjust processor voltage and core frequency, which can result in decreased average power consumption and decreased average heat production

CPU C state Report

Enable or disable the CPU C-states.

3.2.4 SATA Configuration

BIOS SETUP UTILITY		
SATA Configuration		SATA Ports (0-3) Device Names if Present and Enabled.
Serial ATA Port1	Not Present	→ ← : Select Screen ↑ ↓ : Select Item Enter: Select +/-: Change Opt. F1: General Help F9: Optimized Defaults F10: Save&Exit ESC: Exit
Serial ATA Port2	Not Present	
Serial-ATA Controller(s)	[Enabled]	
SATA Mode	[AHCI]	
Serial ATA Port1	[Enabled]	
Serial ATA Port2	[Enabled]	
Version 2.10.1208. Copyright (C) 2010 American Megatrends, Inc.		

Serial-ATA Controller (S)

To enable or disable the SATA controller (S).

SATA Mode

To configure the SATA Mode: [AHCI] or [IDE].

Serial ATA Port1/2

To enable or disable the two ports (SATA & CF) under AHCI mode.

3.2.5 USB Configuration

BIOS SETUP UTILITY	
USB Configuration	Enable / Disable USB Function.
USB Devices: 1 Keyboard , 1 Mouse	→←: Select Screen ↑ ↓: Select Item
USB function [Enabled]	Enter: Select
USB 2.0 (EHCI) Support [Enabled]	+/-: Change Opt.
Legacy USB Support [Enabled]	F1: General Help
Mass Storage Devices;	F9: Optimized Defaults
KingstonDataTraveler G2 PMAP [Auto]	F10: Save&Exit
	ESC: Exit
Version 2.10.1208. Copyright (C) 2010 American Megatrends, Inc.	

USB function

This option is used to enable or disable the USB port.

USB 2.0 (EHCI) Support

[Enabled]: Enable USB EHCI (USB 2.0) functions, max. transmission rate upto 480Mbps

[Disabled]: Disable USB2.0 function. The transmission rate is 12Mbps.

Legacy USB Support

To support USB device in DOS mode: such as USB Flash Disk, USB keyboard, please select <Enabled> or<Auto>.

If not , pls select < Disabled>

### Mass Storage Devices

To select the types of the connected USB devices. [Auto], or [ floppy] or [Forced FDD], [HDD ] or CD-ROM. System defaults as [Auto].

### 3.2.6 Supper IO Configuration

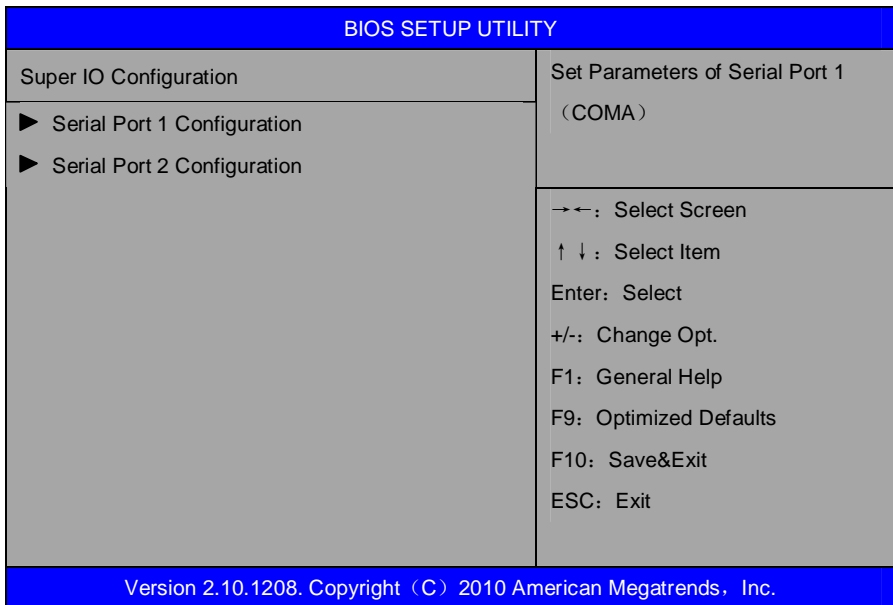

#### Serial Port 1 Configuration

##### 1) Serial Port

To enable or disable the serial port functions. Set Parameters of Serial Port 1.

##### 2) Device Setting (Read Only)

Display serial port IRQ and base address.

##### 3) Change Setting

To change serial port settings. Recommend to select [Auto].

Serial Port 2 Configuration follows the same steps as above.

3.2.7 H/W Monitor

BIOS SETUP UTILITY	
PC Health Status	
SYSTIN temperature	: +28°C
CPUTIN temperature	: +41°C
CPUVCore	: +1.192V
+3.3VIN	: +3.328V
+5VIN	: +4.992V
VBAT	: +3.296V
→←: Select Screen ↑ ↓: Select Item Enter: Select +/-: Change Opt. F1: General Help F9: Optimized Defaults F10: Save&Exit ESC: Exit	
Version 2.10.1208. Copyright (C) 2010 American Megatrends, Inc.	

PC Health Status

PC Health Status Detect. BIOS will display current system temperature, CPU temperature, FAN rotate speed, and related voltage value.

3.2.8 Serial Port Console Redirection

BIOS SETUP UTILITY	
COM1	Console Redirection Enable or Disable.
Console Redirection	[Disabled]
▶ Console Redirection Settings	





LAN2 Controller	[Enabled]	→ ← : Select Screen ↑ ↓ : Select Item Enter: Select +/-: Change Opt. F1: General Help F9: Optimized Defaults F10: Save&Exit ESC: Exit
Restore AC Power Loss	[Power On]	
Power On Bypass	[Disabled]	
Power Off Bypass	[Disabled]	
Version 2.10.1208. Copyright (C) 2010 American Megatrends, Inc.		

**LAN 1-4 Controller**

To enable or disable onboard LAN controller for LAN1 to LAN4.

**Restore AC Power Loss**

To select the computer starting up status after restoring the AC power

- [Power Off]: press the power buttong to start the computer;
- [Power On]: Computer starts up directly after restoring the AC power;
- [Last State]: Return to the last status when the AC power loss.

**Bypass Power On**

Enable or disable the bypass function when system power on

**Bypass Power Off**

Enable or disable the bypass function under Power Off Status.

**3.4 Boot Menu**

BIOS SETUP UTILITY		
Boot Configuration		Number of seconds to wait for setup activation key. 65535(0×FFFF) means indefinite waiting.
Setup Prompt Timeout	1	

Bootup Numlock State [On] Show Full Logo [Enabled]  Boot Option Priorities Boot Option #1 [SATA PM:WDC WD10... ] Boot Option #2 [UEFI: Built-in EFI...]  Hard Drive BBS Priorities	→ ← : Select Screen ↑ ↓ : Select Item Enter: Select +/-: Change Opt. F1: General Help F9: Optimized Defaults F10: Save&Exit ESC: Exit
Version 2.10.1208. Copyright (C) 2010 American Megatrends, Inc.	

**Setup Prompt Timeout**

Number of seconds to wait for setup activation key. 60s is the maximum seconds of timeout. If don't press setup key within the preset time, system will continue to start.

**Bootup Numlock State**

This function allows users to activate Numlock function when system boots up.

[ON]:Numlock open when boot up

[OFF]: Numlock under cursor control

**Show Full Logo**

[Enabled]: Computer boot screen will show supplier's LOGO.

[Disabled]: Self-detect info will show when system boots

**Boot Option #1/2**

System will detect devices according to the preset sequency until to find a boot device. Option #1 is the prior boot device.

**Hard Drive BBS Priorities**

This option contains HDD that can be used as boot device. If multiple HDDs in this option, priority should set for these HDDs, then the prior one will show in Boot Option #1.

### 3.5 Security Menu

BIOS SETUP UTILITY	
Password Description  The password length must be in the following range: Minimum length                      1 Maximum length                        20  Administrator Password User Password	Set Administrator Password  →←: Select Screen ↑↓: Select Item Enter: Select +/-: Change Opt. F1: General Help F9: Optimized Defaults F10: Save&Exit ESC: Exit
Version 2.10.1208. Copyright (C) 2010 American Megatrends, Inc.	

The password length: Min: 1 character; Maximum: 20 characters.

#### Administrator Password

To setup administrator password.

#### User Password

To setup user password. If you have set the password, system will display [Installed]. If not, system will display [Not Installed].

### 3.6 Save & Exit Menu

BIOS SETUP UTILITY	
Load Defaults Save Changes and Exit Discard Changes and Exit	Restore/Load Default values for all the setup options.

	<p>→ ← : Select Screen ↑ ↓ : Select Item Enter: Select +/-: Change Opt. F1: General Help F9: Optimized Defaults F10: Save&amp;Exit ESC: Exit</p>
Version 2.10.1208. Copyright (C) 2010 American Megatrends, Inc.	

**Load Defaults**

Restore/Load Default values for all the setup options.

**Save Change and Exit**

Press [Enter] to select this option and press [Enter] to confirm to save all BIOS changes and Exit.

**Discard Change and Exit**

Press [Enter] to select this option and press [Enter] to confirm to discard all changes and exit.

## Chapter 4 Install & Replace Components

## Chapter 4 Install and Replace Computer Components

### Recommended Tools

You may use following tools :

- Small plum screwdriver
- BIS-6650LC accessory box

### Turn Off the Computer Power

 to avoid data loss, please save all opened files and exit all programs before shutting down the computer.

1. Close the operating system

- Save and close all open files, and exit all open programs, click “start” button and then click “turn off computer” to shut down the computer.
- At the “Turn off computer” window, please click “Turn off”. Then computer will turn off power when computer end operating system and shut down programs.

2. Please make sure computer and all devices have been power off If the computer and all connected devices do not close automatically, please continue to press down the power button for 4 seconds.

### Before disassembling or assembling the computer components:

Please follow the safety instructions below, which will help to protect the computer from potential damage and personal injury.

 **Please be careful to deal with components and plug-in cards, and please do not touch their connection points. Please hold the edges of the cards or metal bracket. If take other components such as processor, please hold its edges, rather than its Pins**

 Only licensed service technicians can carry out maintenance on your computer. The warranty is not within the scope if you open and repair it without the company’s authorization.

 Disconnect the computer power connector carefully, the power connector has foolproof design, Please must take care.

 To avoid damaging the computer, please follow the steps below to dismantle or assemble the interior components:

1. Turn off the computer power

 To disconnect the network cable, please first unplug the network cable from the

computer, then unplug it from the network cable from its socket on the wall

2. Disconnect all the telephone lines or communication cables from the computer.

3: Disconnect computer and all connected devices with power outlet connection. And press the power button of system board to deduct the residual power.

➡ Before touching any components of the computer, please make sure your hand touch an unpainted metal surface, it will remove the static electricity during the assembly process,

#### 4.1 Remove the Computer Cover

To avoid electric shock, please disconnect the power cable from the computer before you go to remove the top cover of the chassis.

➡ Before touching any components of the computer, please make sure your hand touch an unpainted metal surface, it will remove the static electricity during the assembly process,

1. Pls read and follow the steps mention in the section "Before disassembling or assembling the computer components":

➡ Make sure your desk has enough space for the top cover

➡ Make sure the desktop is flat and surface with protection work, in order to avoid scratching the computer.

2. Use the screwdriver to unscrew the four screws on chassis, and place them in a screw container.



3. Dismantle the chassis top cover and place it in a safe place in case of any scratches





## 4.2 Replace DIMM

BIS-6650LC provides one standard 2GB DDRII RAM. If customers need to change it, please note its capacity and its specification. Please follow the steps below to replace the memory bank:

1. Pls read and follow the steps mention in the section “Before disassembling or assembling the computer components”
2. Use screwdriver to unscrew the L shape bottom cover , then you will see the memory slot and CF card socket.

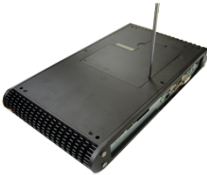

3. Hold the memory clips and force down both sides of it evenly, until the memory bank pops-up
- 4 . Align the memory golden finger with the socket
5. Insert and push the memory into the socket onboard, then press down the memory.
6. Mount the L shape bottom cover
7. Connect the computer and devices with power supply line, then turn on power
8. Right click the “My Computer” icon on the desktop and then click the “Properties”
9. Click “General” option tab
10. If you want to check the installation, please check the listing memory size.

## 4.3 Install CF Card

BIS-6650LC provides one standard 50Pin CF card socket. Please follow the steps below to install the CF Card:

1. Pls read and follow the steps mention in the section “Before disassembling or assembling the computer components”
2. Use screwdriver to unscrew the bottom cover , then you will see the memory slot and CF card socket.
3. Select a matching CF card, then insert it into the CF Card Socket.

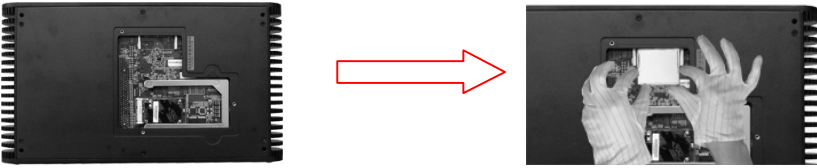

4. Mount the L shape bottom cover

#### 4.4 Mounting Bracket

1 Take out the wall mount bracket and follow the pictures below to align the screw holes and install the wall mount barcket to the base panel of BIS-6650LC

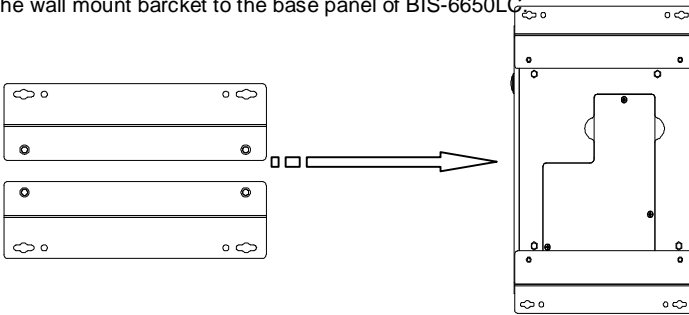

2. Then please place the BIS-6592LC to the right position and screw it tightly.

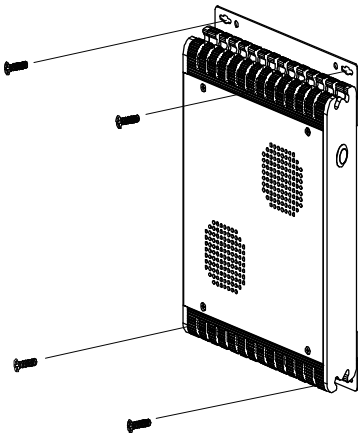

# Appendix

# Appendix

## Appendix 1: Driver Installation

---

---

Please install the driver as per the following steps:

Insert programmed disk into CD-ROM, so installation of the driver can be made either automatically or manually. Now manually installation instructions are given as below:

- 1) A variety of options available regarding manually installation, which you can check from Device Manager.
- 2) Right click "my computer ", select "management", and go to "Device Manager"
- 3) Right click "display controller" in the menu of graphic card, select "Properties ", click "Driver", select "update driver".
- 4) Select "Show the list of all drivers which are designated locations so that choices can be made from it ", select "next."
- 5) Select the location of display driver, click "ok"
- 6) Implement the installation, restart the system.

Proceed with the installation of other drivers after restarting the system, till all installations are implemented. Then user can see that it says device is working

## Appendix 2: Watchdog Programming Guide

---

---

watchdog reference code (ASM)

-----

Set the port to realize watchdog function through DEBUG order, so that it can carry out Watchdog Timer's various functions.

Port Instruction:

```
void main()
{
    int indexp = 0x2e, datap = 0x2f;
    unsigned char temp;

    outportb(indexp, 0x87);
    outportb(indexp, 0x87); //unlock

    outportb(indexp, 0x2d);
    temp = (unsigned char)inportb(datap);
    temp &= 0xfe;
    outportb(indexp, 0x2d);
    outportb(datap, temp); //set pin for watchdog

    outportb(indexp, 0x07);
    outportb(datap, 0x08);
    outportb(indexp, 0x30);
    outportb(datap, 0x01); //enable logical device
    outportb(indexp, 0xf5);
    outportb(datap, 0x00); //set second
    /*outportb(datap, 0x08); set minute*/

    outportb(indexp, 0xf6);
    outportb(datap, 0x03); //set 3 seconds
```

```
outportb(indexp,0xf7);
```

```
outportb(datap,0x00);
```

```
outportb(indexp,0xaa); //lock
```

```
}
```

## **Appendix 3: GPIO Instruction**

---

---

MITX-6854 provides a twelve way input and a twelve way output programable interface. Input and output of the interfaces are independent. In the GPIO interface, there are 26 Pin which are link to 24 digital bits. This interface is generated by the onboard chip on PCI bus, and the bus number is 0, device number is 18 and function number is 0. This interface is using the 3rd basic address register. According to PCI standard, the basic address are allocated by the BIOS dynamically, and it is a MUST normally to obtain the basic address before program this interface(if there are no other PCI expansion device, the basic address is: CC00H).

GPIO's interface debugging program is attached in the CD in the accessory box . Running the GPIO executable file will start the GPIO debug program.

## **Appendix 4: Glossary**

---

### **ACPI**

Advanced Configuration and Power Management Interface for short. ACPI specifications allow OS to control most power of computer and its extended devices. Windows 98/98SE, Windows 2000 and Windows ME are all support ACPI, it provide users a flexible system power management.

### **ATX**

AT extended, a motherboard layout according with modern standard replaced BabyAT. It changes disposal of many components, and do some new high efficiency design, so it is widely used now.

### **BIOS**

Basic in/out system. It's a kind of software including all in/out control code interface in PC. It will do hardware testing while system booting, then system runs, it provides an interface between OS and hardware. BIOS is stored in a ROM chip.

### **BUS**

In a computer system, it's the channels among different parts for exchanging data; it's also a group of hardware line. BUS here means part lines inside CPU and main components of memory.

### **Chipset**

Integrated chips for executing one or more function. Here "Chipset" means system level chipset structured by Southbridge & Northbridge; it decides motherboard's structure and main functions.

### **CMOS**

Complementary Metal-Oxide Semiconductor, a widely used semiconductor with the characteristic of high speed but low power. CMOS we mention here means part of obligate space in on-board CMOS RAM, for saving date, time, system information and system



parameter etc.

### **COM**

Computer-Output Microfilmer. A universal serial communication interface, usually adopts normative OB 9 connector.

### **DIMM**

Dual-Inline-Memory-Module. It's a small circuit board with memory chipset, providing 64bit RAM bus width.

### **DRAM**

Dynamic Random Access Memorizer. It's a normal type of memory often with a transistor and a capacitance to store 1 bit. With the development of the technology, more and more types and specification of ORAM exist in computer application. Now: SDRAM, DDR SDRAM and RDRAM are generally used.

### **IDE**

Driver specification for integrated device electronics, for connecting HDD / CD-ROM device.

### **IRDA**

Infrared Data Association for short, here means infrared transmit interface, to connect infrared transmit devices. This sort of device transmits data by infrared light-wave without connecting any cables. It has been developed a standard now.

### **LAN**

Network interface. Network grouped by correlative computers in a small area, generally in a company or a building. Local area network is buildup by sever, workstation, some communications links, as a rule. Terminals can access data and devices anywhere through cables, so, many users can share costly device and resource.

### **LED**

Light-Emitting Diode. a semiconductor device that shines when power supply is connected, often use to denote info lightly, for example, to denote power on or HDD work normally.

### **LPT**

Line print terminal. The denomination reserved by DOS, is used to denote universal parallel interface, and connect printer in a general way.

### **PnP**

Plug-and-Play. It is a specification that allows PC to configure its external devices automatically and can work independently without the manual operation by its user. To achieve this function, its BIOS should be able to support PnP and a PnP expansion card.

### **POST**

Self-test when power on. While booting, BIOS will do once uninterrupted testing operation to the system, including RAM, keyboard, hard disk driver etc. Check them in normal situation and work well.

### **PS/2**

A keyboard & mouse connective interface specification developed by IBM. PS/2 is a DIN interface with only 6PIN; it also can connect other devices, like modem.

### **USB**

It is the Universal Serial Bus for short. A hardware interface adapts to low speed external devices, and is always used to connect keyboard, mouse etc. One PC can connect 127 USB devices Max, providing 12Mbit/s transmit bandwidth; USB supports hot swap and multi- data stream, namely, you can plug USB devices while system is running, system can auto-detect and makes it work on.

**华北工控**  
**NORCO**

敬请参阅

<http://www.norco.com.cn>

本手册所提供信息可不经事先通知进行变更

华北工控对所述信息保留解释权

